

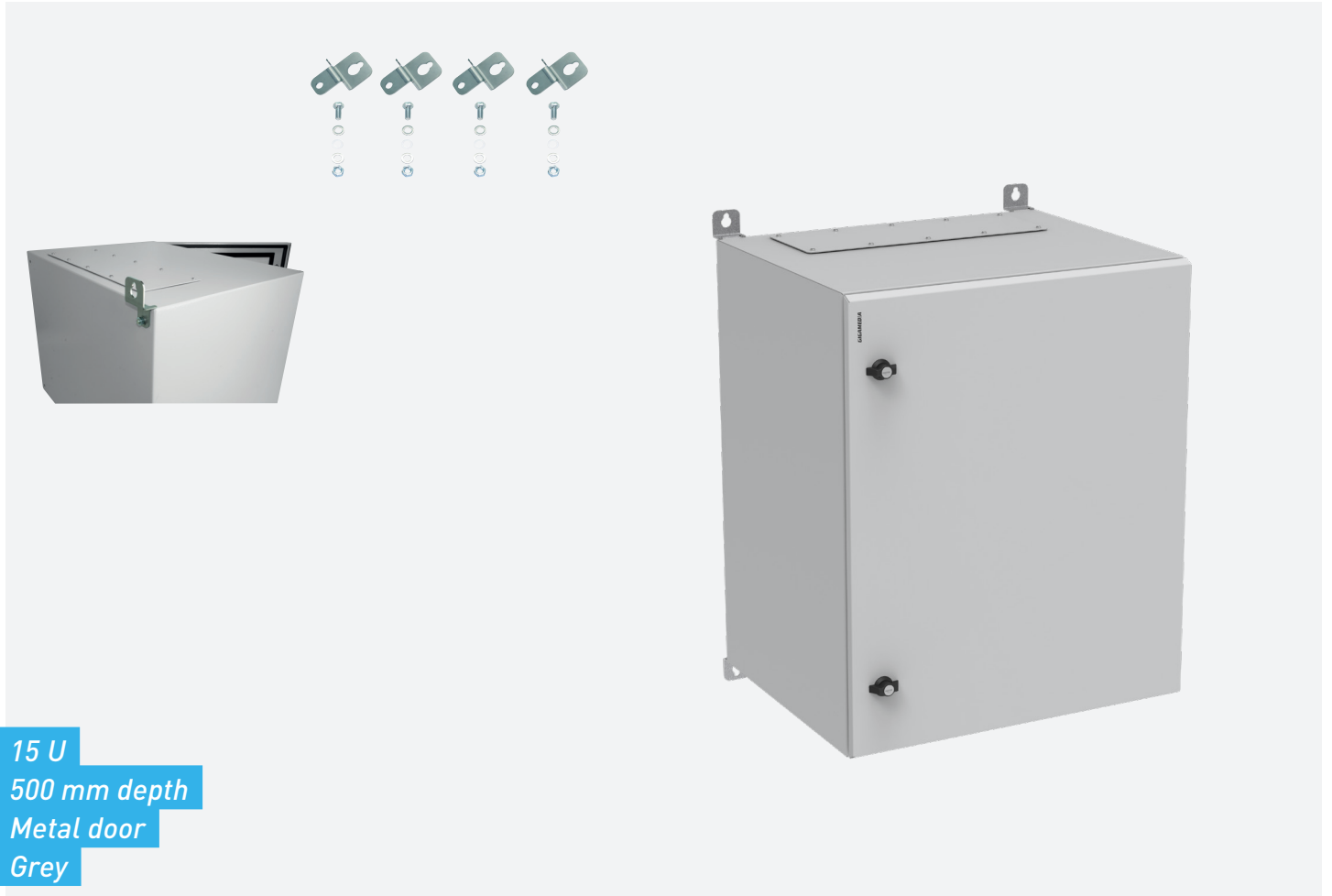

19" CABLING WALLMOUNT CABINET IPBOX GGM COF15U500IP55P



15 U
500 mm depth
Metal door
Grey

Specially designed to meet (according to classification) the required demands within some premises (Industry, warehouse, car park ...). The IPBOX is characterised by the sealing level it has against dust and water jets from all lance directions, according to the CEI 60529 standard.

- ▶ Available with securit glass door with steel frame, or with full steel door.
- ▶ Door with polyurethane hot-poured door seal.
- ▶ Two locking points to ensure uniform pressure of the door seal on the body of the housing.
- ▶ "Butterfly button" type key locks for better handling ergonomics
- ▶ Cable gland plates (top and bottom) with hot-poured polyurethane seal, fixing by screws.
- ▶ Delivered with wall mounting brackets.
- ▶ A pole mounting bracket is also available (sold separately).

A high quality product, both in design and finish, it will meet with the most stringent requirements.

FEATURES

Type :	2 parts
Frame :	Zinc plated steel, mechanically welded, Steel, mechanically welded
Mounting profiles :	Two 19'' mounting profiles adjustable in depth (zinc plated), Two 19'' mounting profiles adjustable in depth (zinc plated)
Front door :	Reversible securit glass door with steel frame or full metal (depending to the versions) , can be opened up to 180°, locked by using key lock (N°333)
Cable entries :	On the top and on the bottom
Width :	600 mm
Depth :	500 mm
RAL Color :	7035 (Grey)
Protection :	IP 55
Load capacity :	60 kg
Earthing kit included :	Yes
Capacity :	15 U
Height :	738 mm

PART NUMBER

DESCRIPTION

GGM C0F15U500IP55P	19'' Wallmount cabinet IPBOX 15U 500 mm depth - Metal door - Grey
---------------------------	---